



SPY DOWNLIGHT - KEYHOLE

DESCRIPTION : ADJUSTABLE DOWNLIGHT WITH KEYHOLE FACEPLATE

CODES : 2754

COLOURS :

TRIM : WHITE OR BLACK

BODY : WHITE OR BLACK

COLOUR TEMPERATURE : 2700K, 3000K

CRI : ≥ 92

LUMENS : 580lm

INPUT VOLTAGE : 240V

WATTAGE : 9.5W

BEAM ANGLE : 60°, 38°, 24°, 15°, 7°

DIMMABLE : YES
PHASE, AUTOMATION, DALI

DRIVER : INCORPORATED

IP RATING : IP20

CUT OUT : 89mm

100MM

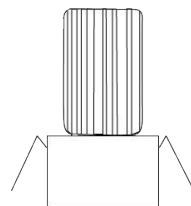
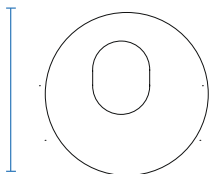

110mm

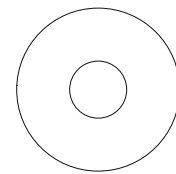

100mm

SPY DOWNLIGHT - PINHOLE

DESCRIPTION : ADJUSTABLE DOWNLIGHT WITH PINHOLE FACEPLATE

CODES : 2758

COLOURS :

TRIM : WHITE OR BLACK

BODY : WHITE OR BLACK

COLOUR TEMPERATURE : 2700K, 3000K

CRI : 92

LUMENS : 580lm

INPUT VOLTAGE : 240V

WATTAGE : 9.5W

BEAM ANGLE : 60°, 38°, 24°, 15°, 7°

DIMMABLE : YES
PHASE, AUTOMATION, DALI

DRIVER : INCORPORATED

IP RATING : IP20

CUT OUT : 89mm



PHOTOMETRY

MODEL	KEYHOLE DOWNLIGHT WITH BT LED v6.8 LAMP		
NOMINAL POWER	9.5W	LIGHT OUTPUT RATIO	100%
RATED VOLTAGE	240V	CIE CLASS	DIRECT
NOMINAL FLUX	762.63 LM	UP	0.1%
LAMPS INSIDE	1	DOWN	99.9%
IMAX	961.2 CD	EFFICIENCY	80.20 LM/W

CANDELA DISTRIBUTION

VERTICAL ANGLE	HORIZONTAL ANGLE								ZONAL LUMENS
	0°	45°	90°	135°	180°	225°	270°	315°	
10	874.6	869.8	889.0	910.6	903.4	880.9	868.1	873.3	88.14
20	642.0	651.6	670.3	688.0	685.9	664.4	636.9	623.0	306.3
30	344.5	372.7	396.5	402.9	400.5	371.4	337.4	323.5	539.3
40	119.1	143.3	158.9	137.0	157.9	138.2	114.9	109.8	690.0
50	28.31	23.87	22.48	21.02	21.31	21.61	25.16	27.12	740.1
60	12.20	9.888	8.162	6.467	6.803	8.035	9.791	10.81	753.8
70	5.147	3.866	2.539	2.309	1.503	2.602	3.876	5.090	759.1
80	2.693	1.743	0.8730	0.9571	0.0791	0.6308	1.661	2.543	761.7
90	0.0007	0	0	0	0	0	0	0	762.2
100	0	0	0	0	0	0	0	0	762.2
110	0	0	0	0	0	0	0	0	762.2
120	0	0	0	0	0	0	0	0	762.2
130	0	0	0	0	0	0	0	0	762.2
140	0	0	0	0	0	0	0	0	762.2
150	0	0	0	0	0.3966	0.3158	0.3955	0.3978	762.3
160	0.1583	0.2353	0.1582	0.1577	0.6331	0.7098	0.7118	0.6365	762.4
170	0.6297	0.6255	0.5518	0.4799	0.6331	0.7098	0.7118	0.6365	762.6
180	0.7122	0.7912	0.8700	0.7161	0.6331	0.7098	0.7118	0.6365	762.6

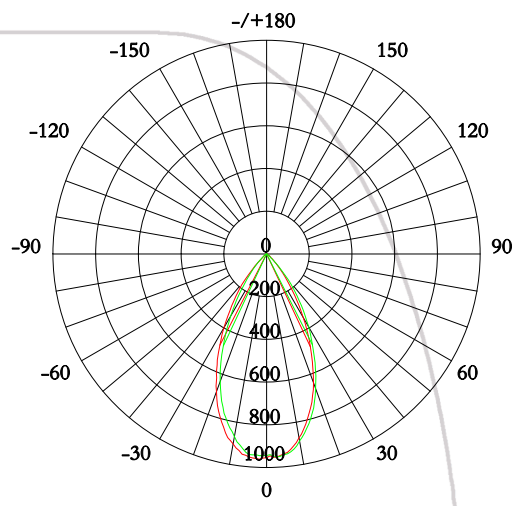

AVERAGE BEAM ANGLE UNIT: CD
 (50%): 52.2°
 — C0 180°, 52.4°
 — C90 270°, 52.1°

VERTICAL ANGLE	HORIZONTAL ANGLE	
	0	90
85	573	37
80	610	198
75	626	265
70	592	292
65	671	318
60	959	642
55	1270	949
50	1732	1375
45	3441	3736

COEFFICIENTS OF UTILISATION (%)

CEILING	80%			70%			50%			30%			10%			0
	50%	30%	10%	50%	30%	10%	50%	30%	10%	50%	30%	10%	50%	30%	10%	
WALL	20%															0
FLOOR	20%															0
RCR 0	1.19	1.19	1.19	1.16	1.16	1.16	1.11	1.11	1.11	1.06	1.06	1.06	1.02	1.02	1.02	.00
1	1.11	1.08	1.06	1.08	1.06	1.04	1.04	1.03	1.01	1.01	.99	.98	.97	.96	.95	.93
2	1.03	.99	.95	1.01	.97	.94	.98	.95	.92	.95	.92	.90	.92	.90	.88	.87
3	.96	.91	.87	.94	.90	.86	.92	.88	.85	.89	.86	.83	.87	.84	.82	.81
4	.90	.84	.80	.88	.83	.79	.86	.82	.78	.84	.80	.77	.82	.79	.76	.75
5	.84	.78	.74	.83	.77	.73	.81	.76	.73	.79	.75	.72	.78	.74	.71	.70
6	.79	.73	.68	.78	.72	.68	.76	.71	.68	.75	.71	.67	.74	.70	.67	.65
7	.74	.68	.64	.73	.68	.64	.72	.67	.63	.71	.66	.63	.70	.66	.63	.61
8	.70	.64	.60	.69	.64	.60	.68	.63	.59	.67	.63	.59	.66	.62	.59	.58
9	.66	.60	.56	.66	.60	.56	.65	.59	.56	.64	.59	.56	.63	.59	.55	.54
10	.63	.57	.53	.62	.57	.53	.61	.56	.53	.60	.56	.53	.60	.55	.52	.51

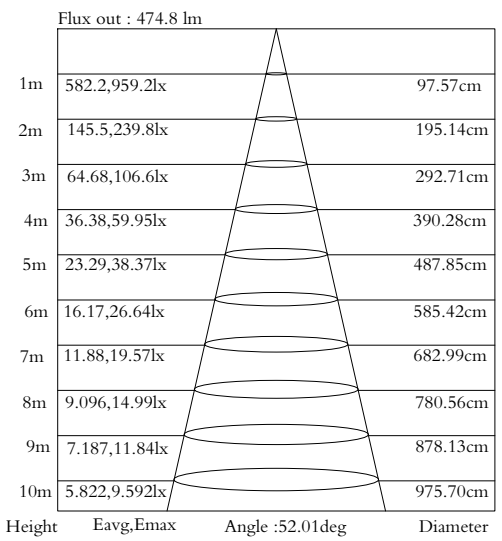

BODY

THE KEYHOLE DOWNLIGHT WITH HEAVY DUTY PLASTIC BODY AVAILABLE IN WHITE OR BLACK. THE FACEPLATE IS POWDERCOATED AND IS ALSO AVAILABLE IN COPPER OR STAINLESS STEEL.

LAMP

BRIGHTTEK LED LAMP WITH DIMMABLE A 36V 250h LED DRIVER. THE BT LAMP IS AVAILABLE IN A WARM WHITE 2700K AND 3000K. 4000K IS AVAILABLE ON CUSTOM REQUEST.

INSTALLATION

RECESSED DOWNLIGHT. 89MM CUT

POWER SUPPLY

24V LED FLEX & PLUG DRIVER

WEIGHT

200G

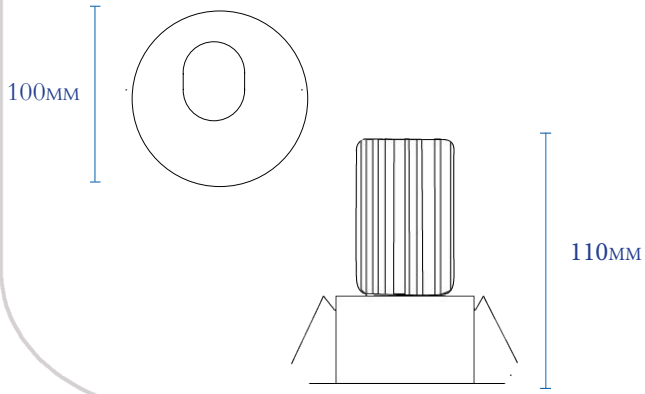



PHOTOMETRY

MODEL PINHOLE DOWNLIGHT WITH BT LED v6.8 LAMP

NOMINAL POWER	9.5W	LIGHT OUTPUT RATIO	100%
RATED VOLTAGE	240V	CIE CLASS	DIRECT
NOMINAL FLUX	762.63 LM	Up	0.1%
LAMPS INSIDE	1	DOWN	99.9%
IMAX	961.2 CD	EFFICIENCY	80.20 LM/W

CANDELA DISTRIBUTION

VERTICAL ANGLE	HORIZONTAL ANGLE								ZONAL LUMENS
	0°	45°	90°	135°	180°	225°	270°	315°	
10	874.6	869.8	889.0	910.6	903.4	880.9	868.1	873.3	88.14
20	642.0	651.6	670.3	688.0	685.9	664.4	636.9	623.0	306.3
30	344.5	372.7	396.5	402.9	400.5	371.4	337.4	323.5	539.3
40	119.1	143.3	158.9	137.0	157.9	138.2	114.9	109.8	690.0
50	28.31	23.87	22.48	21.02	21.31	21.61	25.16	27.12	740.1
60	12.20	9.888	8.162	6.467	6.803	8.035	9.791	10.81	753.8
70	5.147	3.866	2.539	2.309	1.503	2.602	3.876	5.090	759.1
80	2.693	1.743	0.8730	0.9571	0.0791	0.6308	1.661	2.543	761.7
90	0.0007	0	0	0	0	0	0	0	762.2
100	0	0	0	0	0	0	0	0	762.2
110	0	0	0	0	0	0	0	0	762.2
120	0	0	0	0	0	0	0	0	762.2
130	0	0	0	0	0	0	0	0	762.2
140	0	0	0	0	0	0	0	0	762.2
150	0	0	0	0	0.3966	0.3158	0.3955	0.3978	762.3
160	0.1583	0.2353	0.1582	0.1577	0.6331	0.7098	0.7118	0.6365	762.4
170	0.6297	0.6255	0.5518	0.4799	0.6331	0.7098	0.7118	0.6365	762.6
180	0.7122	0.7912	0.8700	0.7161	0.6331	0.7098	0.7118	0.6365	762.6

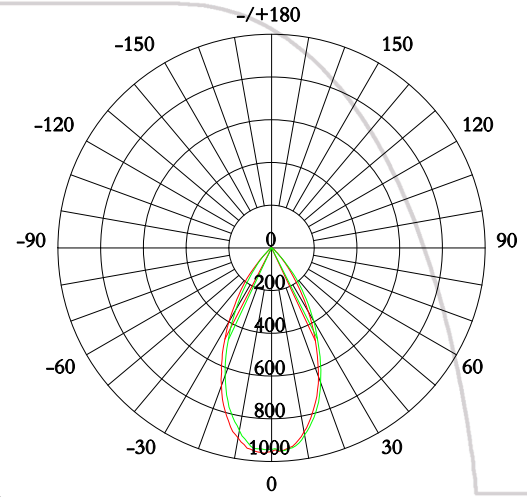

AVERAGE BEAM ANGLE UNIT: CD
 (50%): 52.2°
 — C0 180°, 52.4°
 — C90 270°, 52.1°

VERTICAL ANGLE	HORIZONTAL ANGLE	
	0	90
85	573	37
80	610	198
75	626	265
70	592	292
65	671	318
60	959	642
55	1270	949
50	1732	1375
45	3441	3736

COEFFICIENTS OF UTILISATION (%)

CEILING	80%			70%			50%			30%			10%			0
	50%	30%	10%	50%	30%	10%	50%	30%	10%	50%	30%	10%	50%	30%	10%	
WALL																0
FLOOR																0
RCR 0	1.19	1.19	1.19	1.16	1.16	1.16	1.11	1.11	1.11	1.06	1.06	1.06	1.02	1.02	1.02	.00
1	1.11	1.08	1.06	1.08	1.06	1.04	1.04	1.03	1.01	1.01	.99	.98	.97	.96	.95	.93
2	1.03	.99	.95	1.01	.97	.94	.98	.95	.92	.95	.92	.90	.92	.90	.88	.87
3	.96	.91	.87	.94	.90	.86	.92	.88	.85	.89	.86	.83	.87	.84	.82	.81
4	.90	.84	.80	.88	.83	.79	.86	.82	.78	.84	.80	.77	.82	.79	.76	.75
5	.84	.78	.74	.83	.77	.73	.81	.76	.73	.79	.75	.72	.78	.74	.71	.70
6	.79	.73	.68	.78	.72	.68	.76	.71	.68	.75	.71	.67	.74	.70	.67	.65
7	.74	.68	.64	.73	.68	.64	.72	.67	.63	.71	.66	.63	.70	.66	.63	.61
8	.70	.64	.60	.69	.64	.60	.68	.63	.59	.67	.63	.59	.66	.62	.59	.58
9	.66	.60	.56	.66	.60	.56	.65	.59	.56	.64	.59	.56	.63	.59	.55	.54
10	.63	.57	.53	.62	.57	.53	.61	.56	.53	.60	.56	.53	.60	.55	.52	.51

Flux out : 474.8 lm

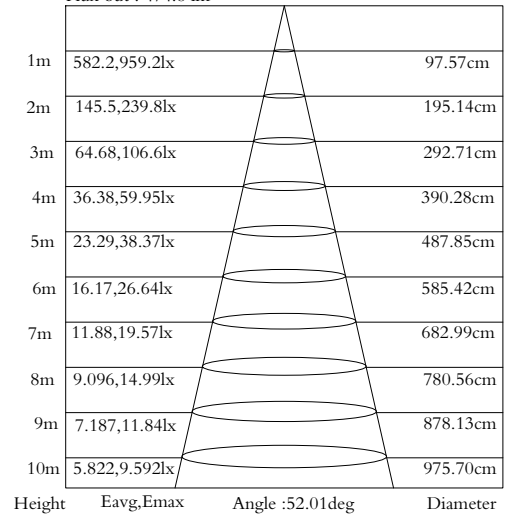

BODY

THE PINHOLE DOWNLIGHT WITH HEAVY DUTY PLASTIC BODY AVAILABLE IN WHITE OR BLACK. THE FACEPLATE IS POWDERCOATED AND IS ALSO AVAILABLE IN COPPER OR STAINLESS STEEL.

LAMP

BRIGHTTEK LED LAMP WITH DIMMABLE A 36V 250h LED DRIVER. THE BT LAMP IS AVAILABLE IN A WARM WHITE 2700K AND 3000K. 4000K IS AVAILABLE ON CUSTOM REQUEST.

INSTALLATION

RECESSED DOWNLIGHT. 89MM CUT

POWER SUPPLY

24V LED FLEX & PLUG DRIVER

WEIGHT

200G

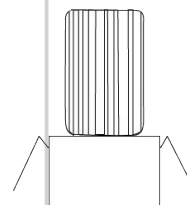

110MM

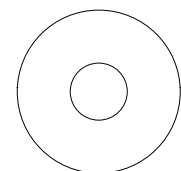

100MM